

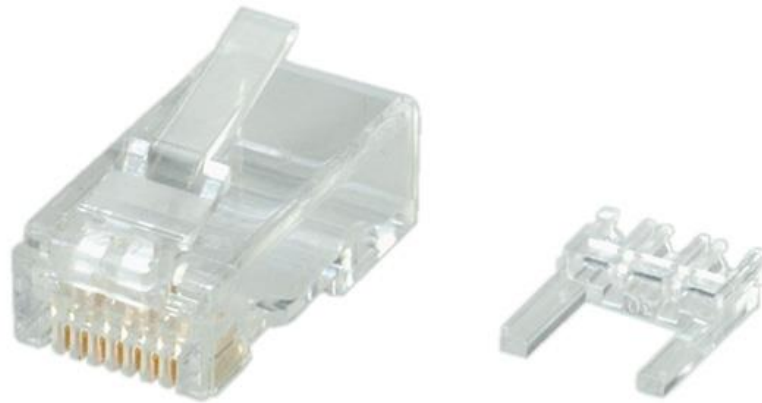

Datenblatt - Fiche technique - Data sheet

21.17.3062



ROLINE Modular Plug ungeschirmt, Kat. 6, für Massivdraht, 10 Stck

ROLINE Connecteur modulaire non blindé Cat. 6 pour câble solide, 10 unités

ROLINE Cat.6 Modular Plug, unshielded, for Solid Wire, 10 pcs.

更改 REV	出图日期 DATE	设变内容 MODIFICATION	修 改 DRAWN
	2010/08/10		

SPECIFICATIONS

1. ELECTRICAL:

UL APPLICATIONS: 250 VOLTS AC MAX., AT 2 AMPS.
 DIELECTRIC WITHSTANDING VOLTAGE: 500 VOLTS AC.
 INSULATION RESISTANCE: 100 MΩ.
 TERMINATION: RESISTANCE 20mΩ MAX AFTER ENVIRONMENTAL TESTING.

2. MECHANICAL:

CABLE-TO-PLUG TENSILE STRENGTH: ~~200~~ND MIN.
 DURABILITY: 200 MATING CYCLES.

3. MATERIAL & FINISH:

HOUSING: POLYCARBONATE, UL94V-0 OR UL94V-2.
 COLOR: TRANSPARENT OR OTHER COLOR ARE AVAILABLE.
 CONTACT BLADE: COPPER ALLOY.
 CONDUCTOR: STRANDED & SOLID WIRE, 24AWG, 26 AWG.
 GOLD PLATING: 3u"~50u", ARE AVAILABLE.

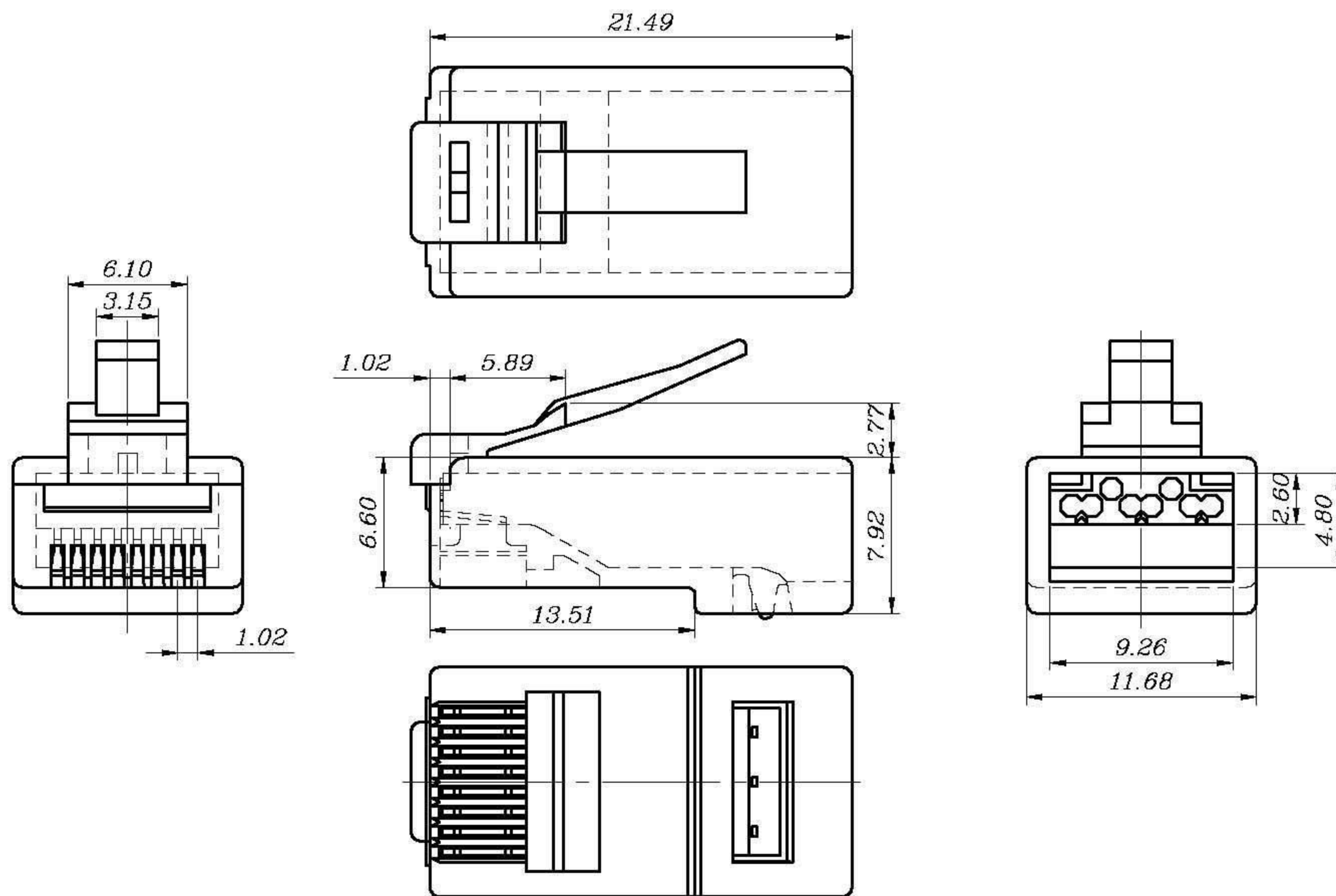

ITEM: 21.17.3062-50

BLADE:	E	Y	Z	A	AB	YL	ZL		
Drawing									
Mark					✓				
GOLD PLATING	3Mu"	3u"	6u"	15u"	30u"	50u"	CABLE TYPE	ROUND	FLAT
Mark					✓	Mark	✓		

客户用产品图

Rotronic Co., Ltd.

DIMENSION IN mm (Inch) TOLERANCE UNLESS OTHERWISE SPECIFIED		材 质 MATERIAL PC	图 号 DWG No. PLUG-031(2.6)
.X±0.20	.X°±5°	名 称 TITLE 21.17.3062	
.XX±0.10	.XX°±2°		
审 核 APPROVAL	核 对 CHECKED	制 图 DRAWN LiWenjuan	比 例 SCALE 5/2
		角 法 PROJ. 	张 数 SHEET 1/1
		更 改 REV A	

ST-DR-009A

更改 REV	出图日期 DATE	设变内容 MODIFICATION	修改 DRAWN
	2010/12/10	减胶变更 △	Zah

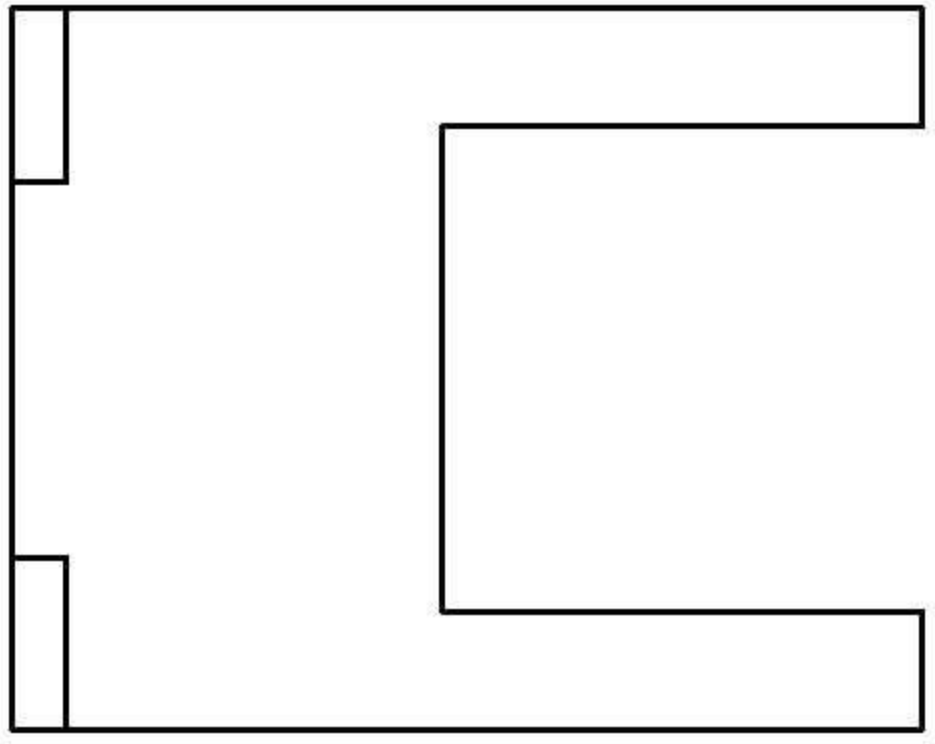
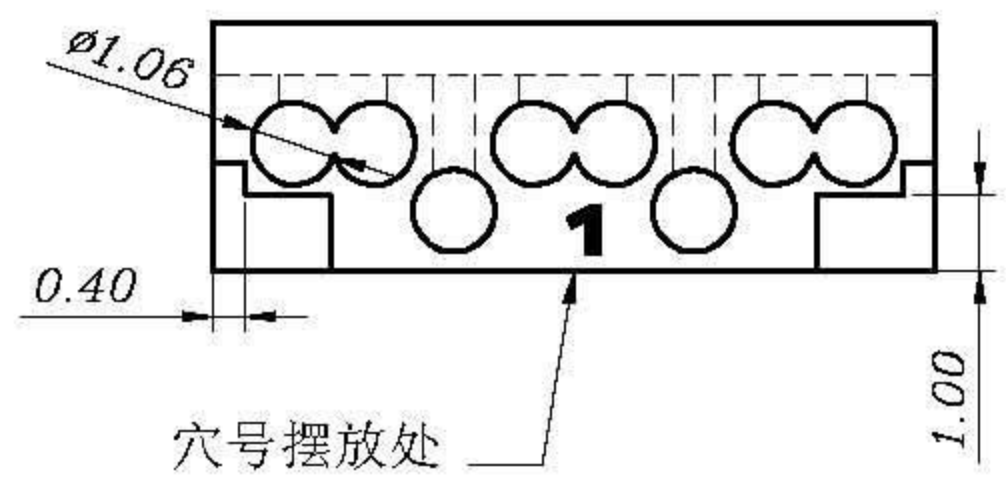
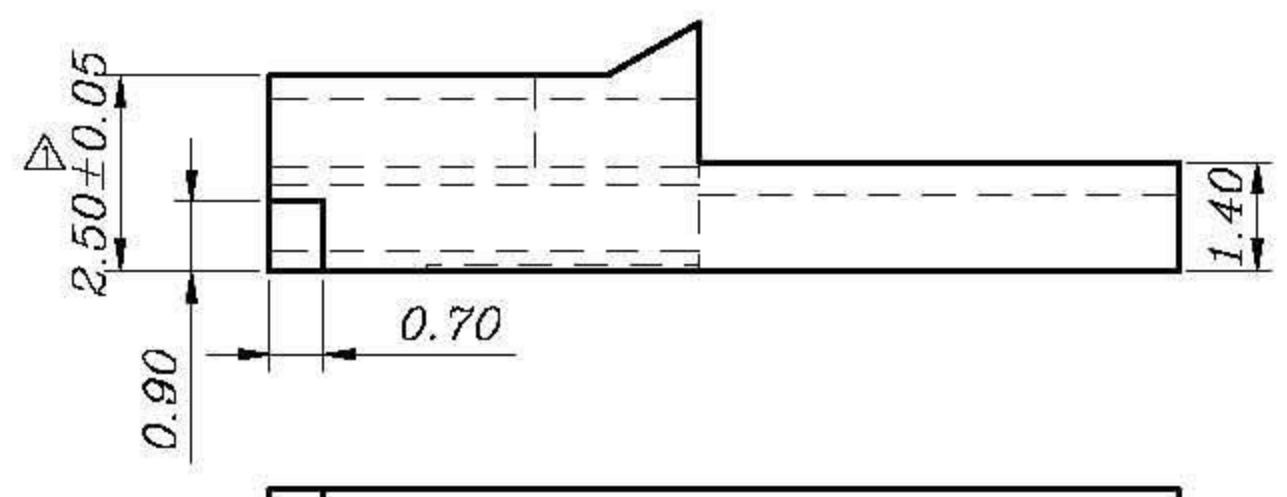
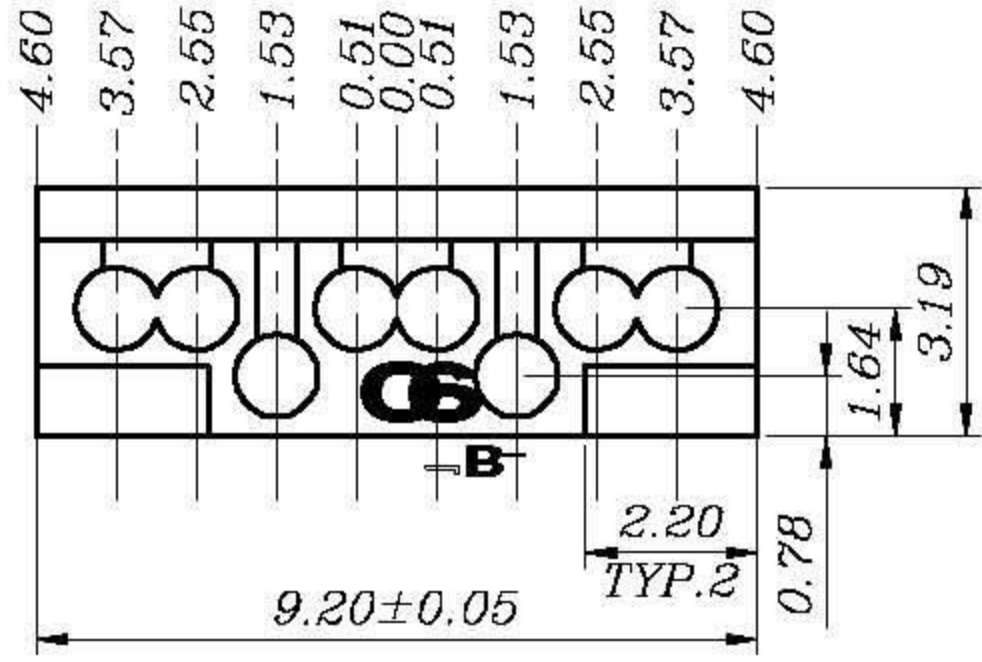
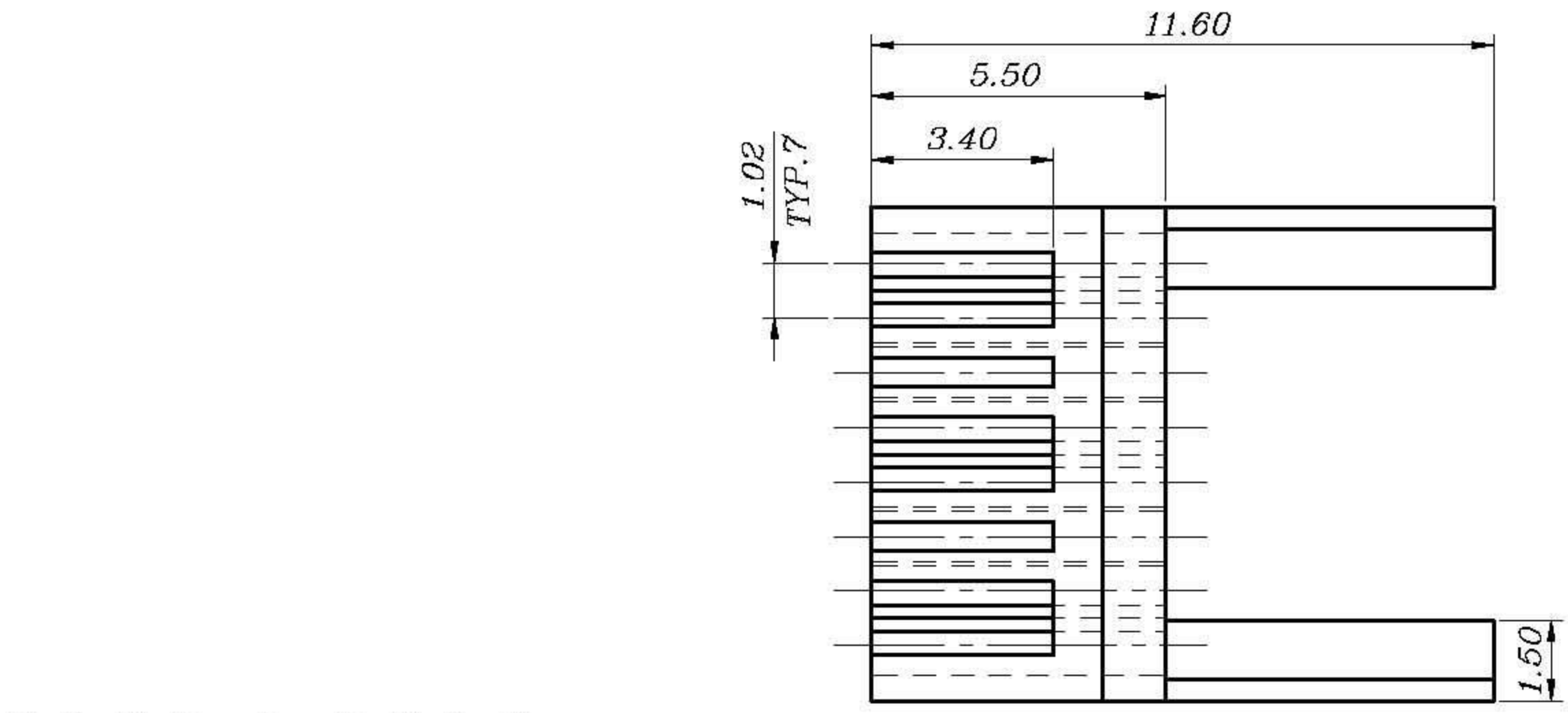

客户用产品图

Rotronic Co., Ltd.

DIMENSION IN mm (Inch) TOLERANCE UNLESS OTHERWISE SPECIFIED		材质 MATERIAL PC	图号 DWG NO. FLIGINERT-07
.X±0.20	.X°±5°	名称 TITLE 21.17.3062	
.XX±0.10	.XX°±2°	制图 DRAWN LiWenjuan	比例 SCALE 5/1
审核 APPROVAL	核 对 CHECKED	角法 PROJ. 	张数 SHEET 1/1
		更改 REV H	

ST-DR-009A