

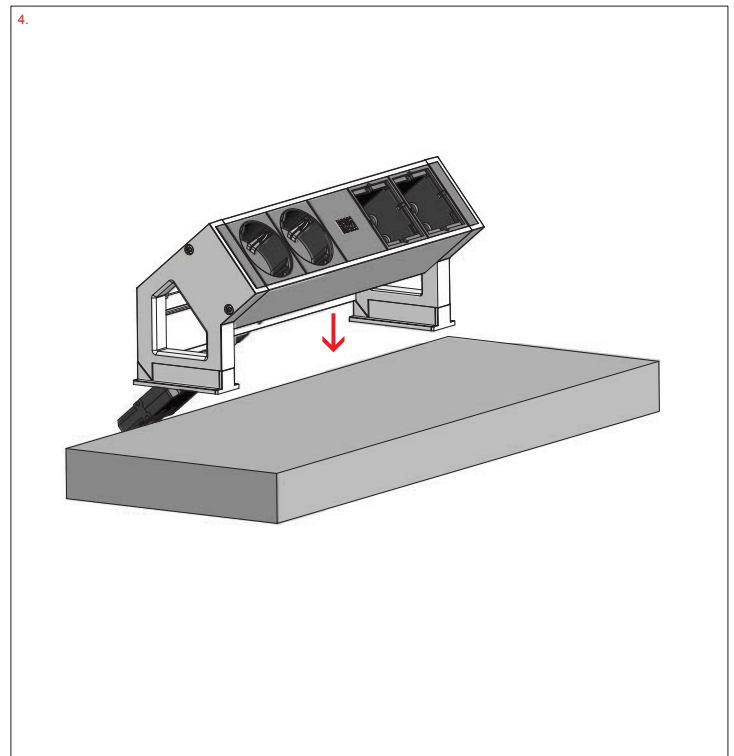

Montage / Mounting

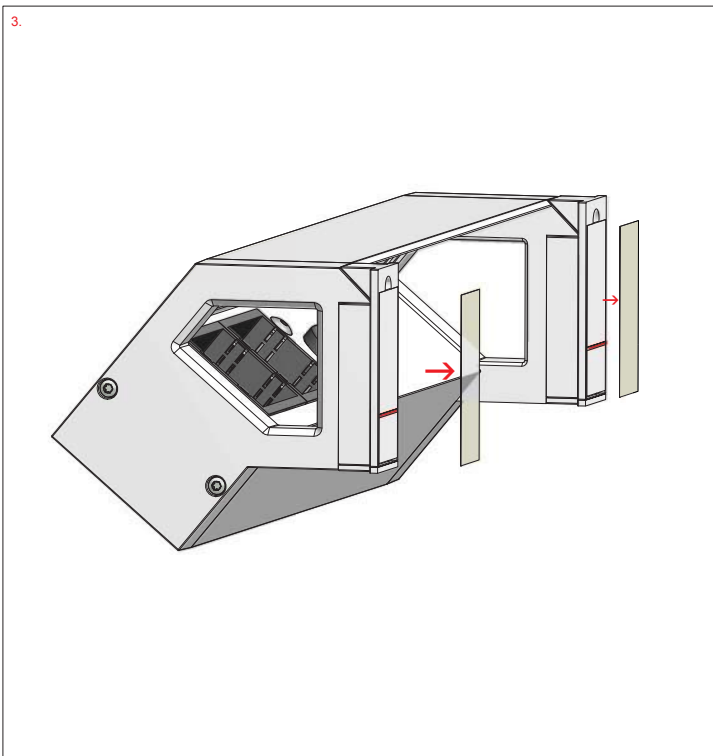
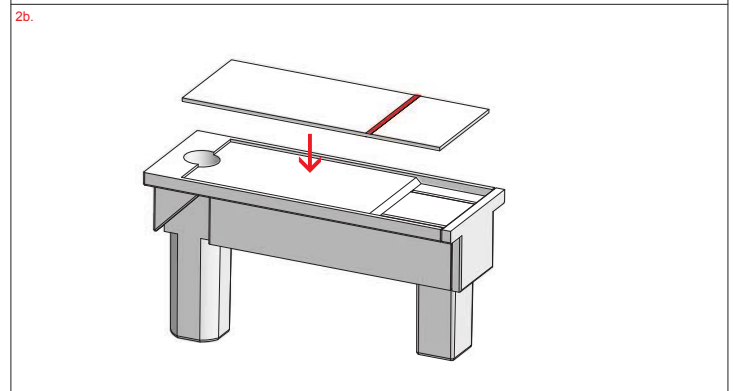
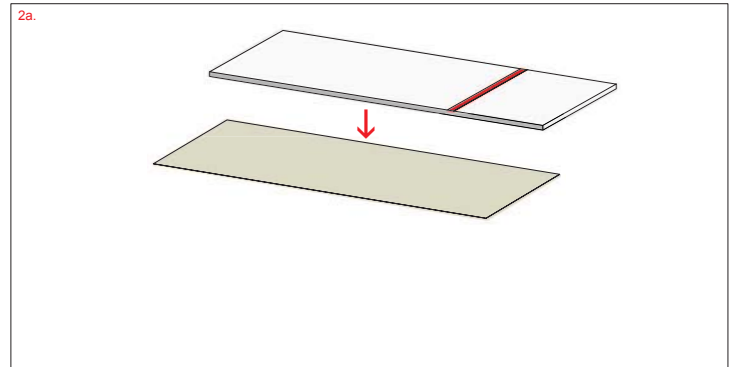
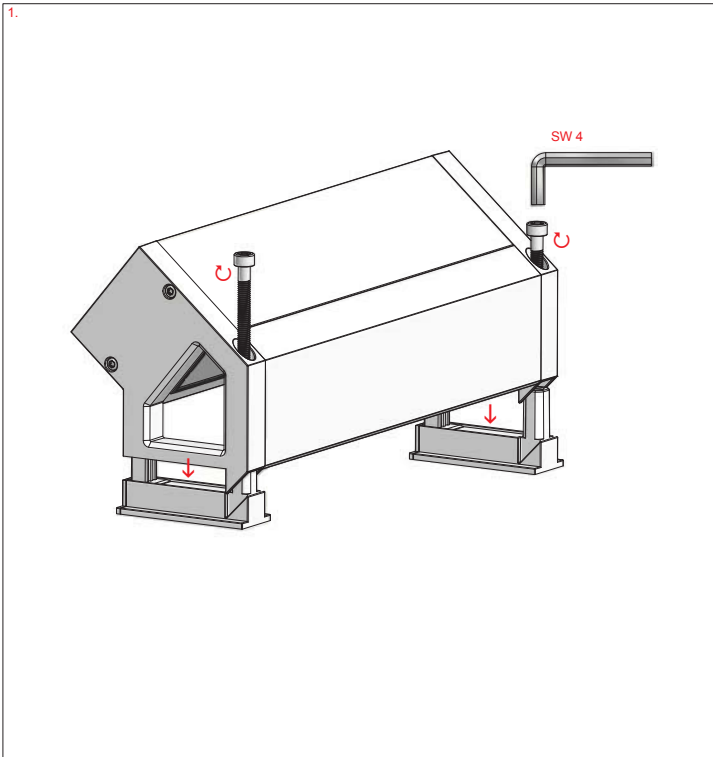

www.bachmann.com			Produkt / Bezeichnung / Title:	
Gezeichnet Drawn by	Datum 28.03.2012	Name tina.laible	Desk 2 Klebesockel / gluing base	
Kontrolliert/ checked by	03.04.2012	Suzana Sucic	Art.-Nr.: 918.110, 918.111	
Freigabe / Approval	13.04.2012	Jens Matheis		
			Zeichnungs Nr. / Drawing No: B0569401BA67	
			Rev.: 01	
<p>Jede Form der unbefugten Nutzung, Veröffentlichung, des Kopierens oder der Offenlegung des Inhalts ist nicht gestattet. Any form of unauthorized use, publication, copying or disclosure of the content is not prohibited</p>				

Demontage / Dismounting

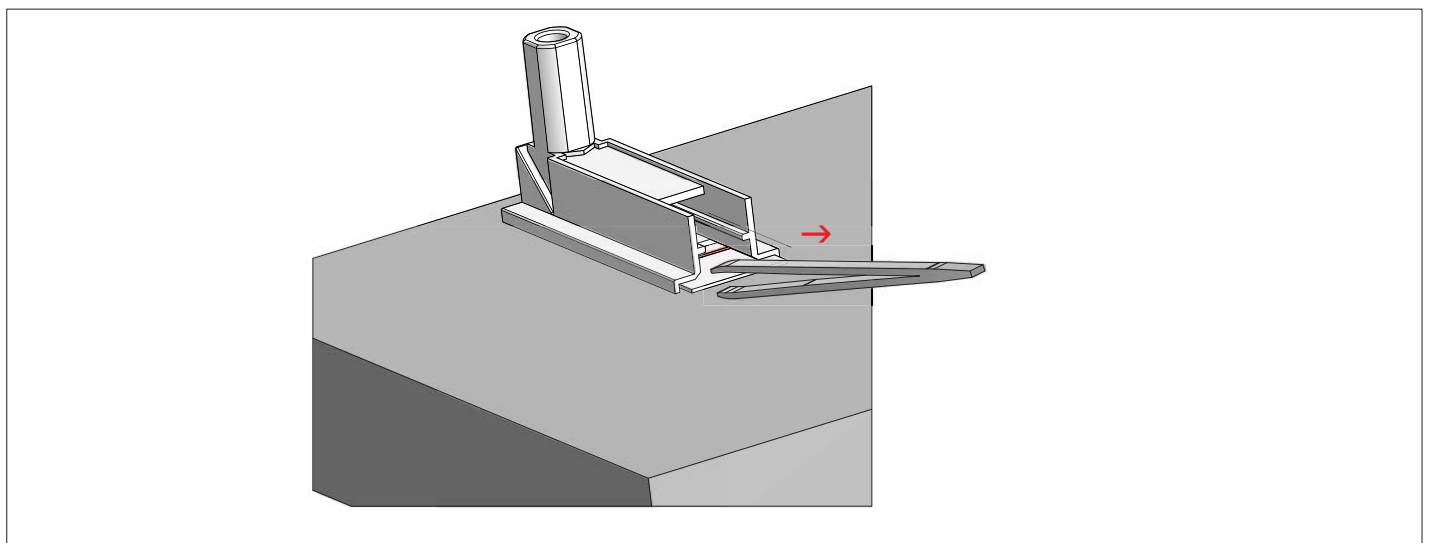
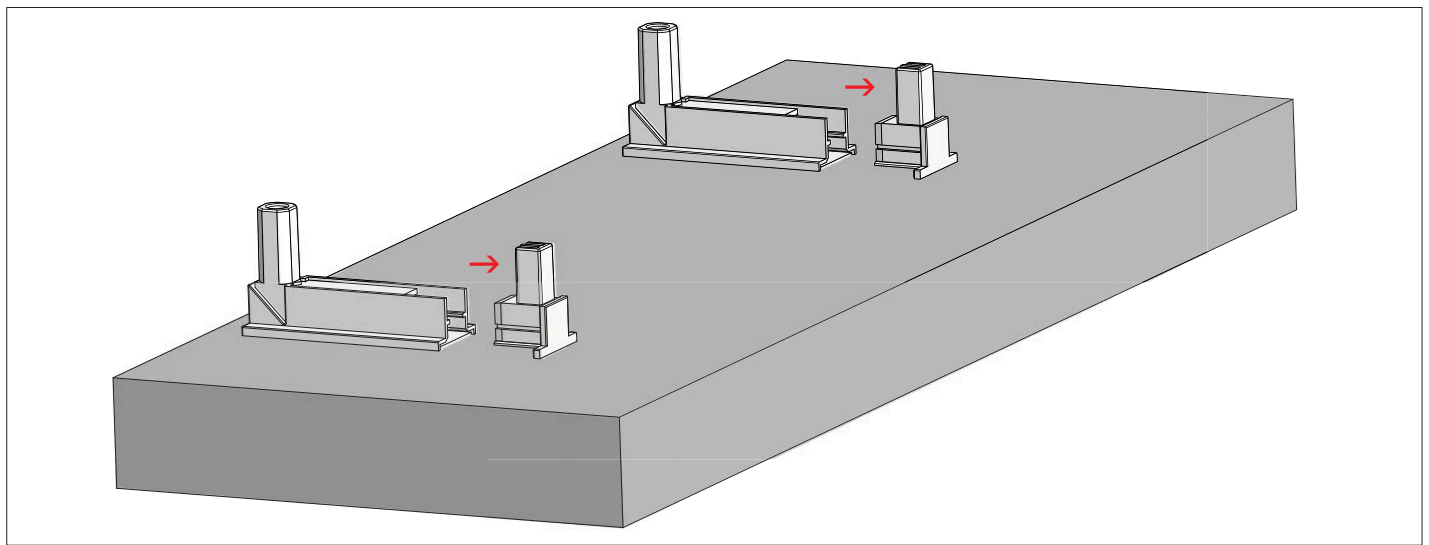
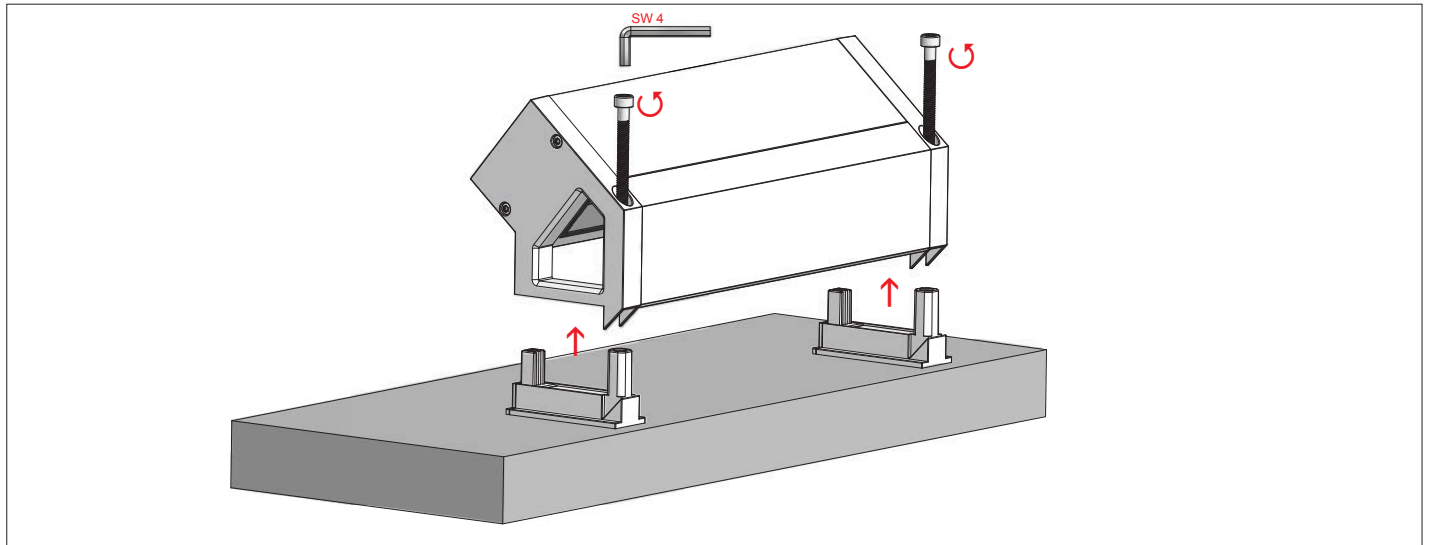

www.bachmann.com			Produkt / Bezeichnung / Title:	
Gezeichnet Drawn by	Datum 28.03.2012	Name tina.laible	Desk 2 Klebesockel / gluing base Art.-Nr.: 918.110, 918.111	
Kontrolliert/ checked by	03.04.2012	Suzana Sucic		
Freigabe / Approval	13.04.2012	Jens Matheis		
BACH MANN			Zeichnungs Nr. / Drawing No: B0569401BA67	
			Rev.: 01	
<p>Jede Form der unbefugten Nutzung, Veröffentlichung, des Kopierens oder der Offenlegung des Inhalts ist nicht gestattet. Any form of unauthorized use, publication, copying or disclosure of the content is not prohibited</p>				