

rotronic

Datenblatt - Fiche technique - Data sheet

21.17.0349



ROLINE MPO-Panel 19" für 3 Module,

ROLINE Panneau MPO 19" pour 3 modules,

ROLINE MPO-Panel 19" for 3 Modules,

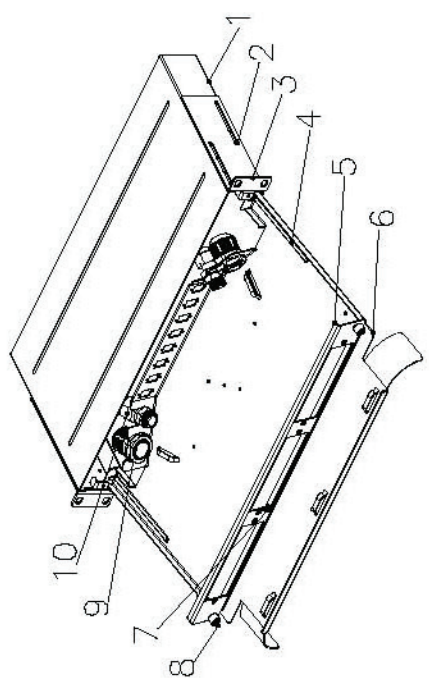

SCALE 1/10

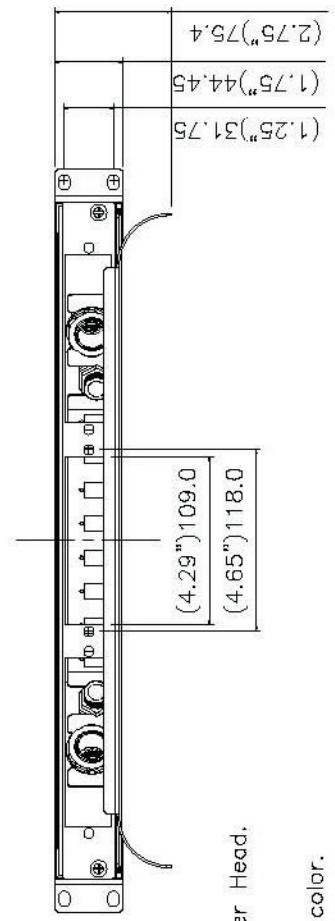
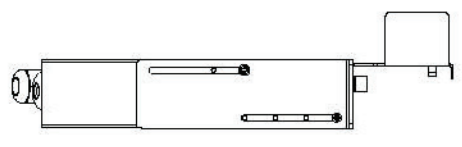
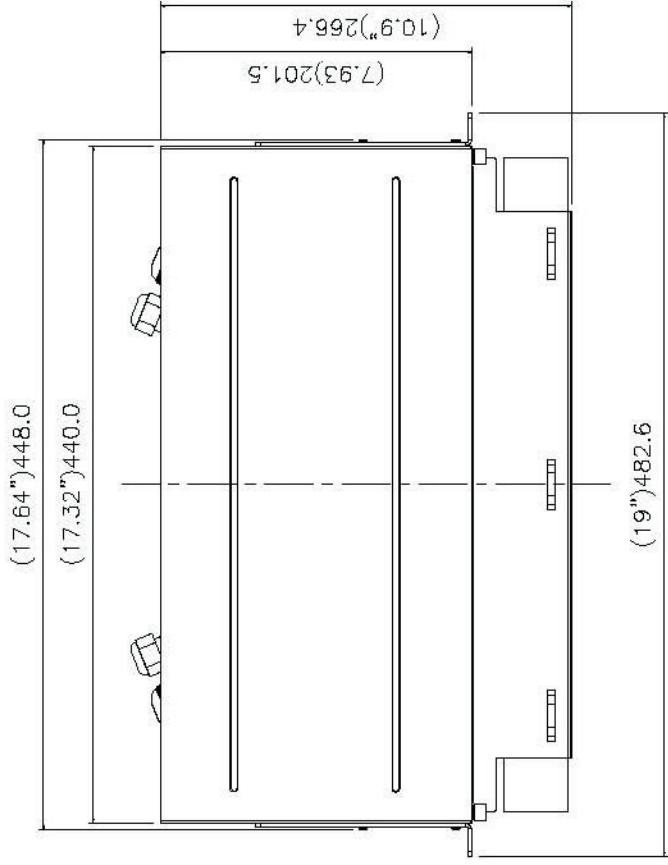

Specification :

Material :

1. Cover : SPCC, 1.2mm Thickness, Black color.
2. Grounding Screw : 4PCS, M3*5mm Zinc Plated, Wafer Head.
3. ledger plate : SPCC, 2.0mm Thickness, Black color.
4. Panel : SPCC, 1.2mm Thickness, Black color.
5. LGX cassette Panel : SPCC, 1.2mm Thickness, Black color.
6. Support bar : SPCC, 1.5mm Thickness, Black color.
7. Mounting Screw : 6PCS, M3*4mm Zinc Plated, Wafer Head.
8. Screw : 2PCS, M3*10.5*13.8mm Zinc Plated, Wafer Head.
9. Cable Glands : AG-25S, NYLON 66, Grey color.
10. Cable Glands : AG-20S, NYLON 66, Grey color.

Performance :

- a. Dimension : 19" x 10.49" x 2.97"
(482.6 x 266.4 x 75.4mm)
- b. Weight : 2.6kg.
- c. Finished: Painted, BK(RAL9005).

GENERAL TOLERANCE OF DIMENSIONS		DRAWING	10.APR.2013	LSQ	rotronic	
X.XXX ±0.005	CHECK	10.APR.2013	DAY			
X.XX ±0.05	APPROVAL	10.APR.2013	JAIMY			
X.X ±0.1	SCALE 1/5(A4)		DATE	NAME	21.17.0349	
DRAWING NO.		ROLINE MPO-PANEL, 19", for 3 Modules, Black				
DRAWING CLASSIFICATION		S SHEET 1 OF 1				

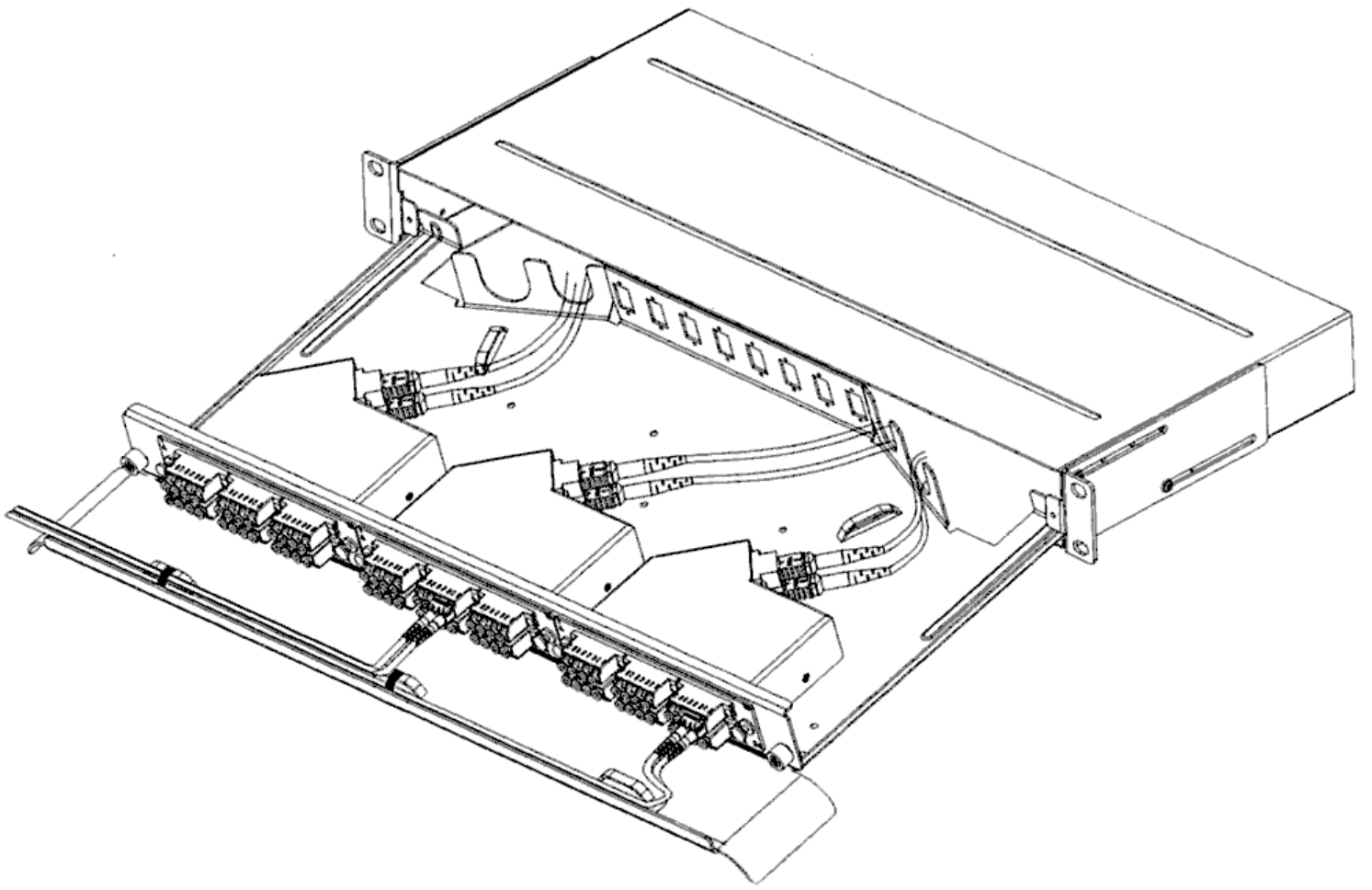

**OM3 LC-LC
(A-B)**



**MPO Module
(12x LC-MPO male)**

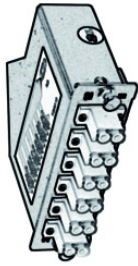

**MPO Trunk Cable
(female-female)**



MPO Coupler



**MPO Fan-Out Cable
(MPO male-12x LC)**

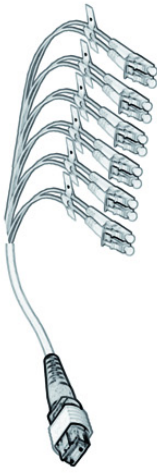

**OM3 LC-LC
(A-B)**



**MPO Module
(MPO male-12x LC)**

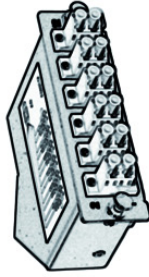

**MPO Trunk Cable
(female-female)**



**OM3 LC-LC
(A-A)**

